

Home Theater Projector

LEGEND GT

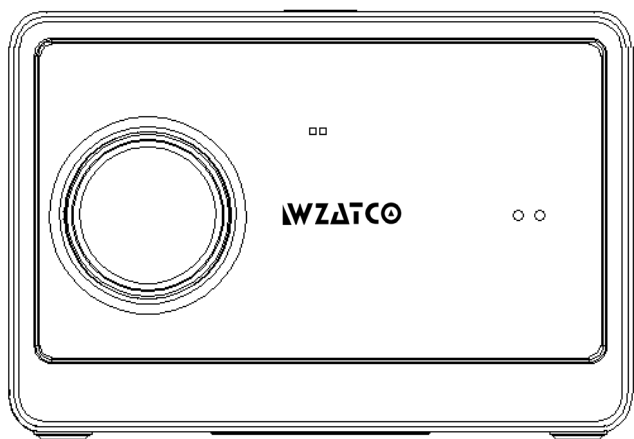

USER MANUAL

CONTENTS

Important Safety Instructions -----	03
Packing List -----	04
Overview -----	05
Remote Control -----	06
Getting Started -----	07
Start Using -----	08
Electronic Keystone Correction -----	09-10
HDMI USB Connection -----	11
Screen Mirroring -----	12
Bluetooth Connection -----	13
Trouble Shooting -----	14

Important Safety Instructions

Thank you for purchasing projector .

Please read this manual thoroughly before using and keep it for future reference

If physical injury , loss of data , or damage is caused by failure to follow instructions , the warranty does not apply

Set Up

- Do not install the projector in places without proper ventilation
- Do not install the projector in hot and humid places
- Do not install the projector in dusty or smokey places .
- Do not block the ventilation holes (intake or exhaust)
- Do not install the projector near the temperature and smoke detectors . It may cause a sensor failure .
- Do not install the projector in areas where warm and cool air will blow directly onto the projector ,otherwise it may cause projector failure due to moisture condensation or large temperature changes

Power Supply

- Power off the device before removing the power supply from the socket
- Use the power cord with caution to avoid unduly bending it Damaged power cords may cause electricshock or fire
- Unplug this device if there are lightning storms or when unused for a long period of time .
- Never touch the power cable or the power connection with wet hands
- Unplug the power cord from the outlet after using the projector

Repairs

- Never make any repairs to the projector yourself
- No components in the projector can be repaired by customers .
- Please entrust qualified professional maintenance personnel for repair .

Caution

- Do not look at the lens or it may cause severe eye injury
 - · During and after use, the temperature near the air outlet will rise, therefore, touching it may cause burns
 - · Do not place projector in too warm or too cold room, because the high temperature or low temperature will shorten lifespan of the device. The working temperature would better be 5°C-35°C
-

Packing List

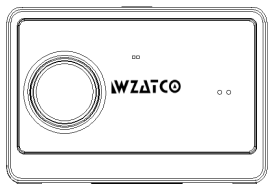

Projector



Remote (Batteries
Not included)



HDMI Cable



Power Cable

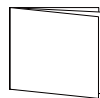

USER MANUAL

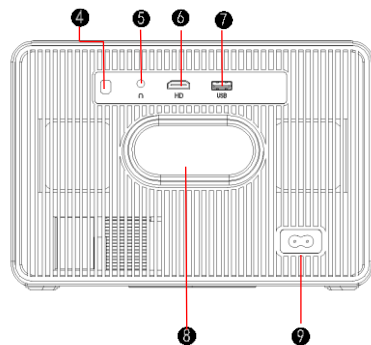
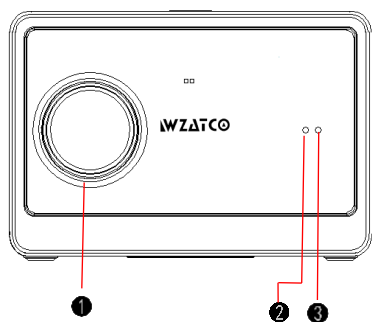

1. Lens cap
2. Camera
3. IR receiver
4. IR receiver
5. 3.5mm port for audio output
6. HDMI
7. USB port
8. Speaker
9. Power interface

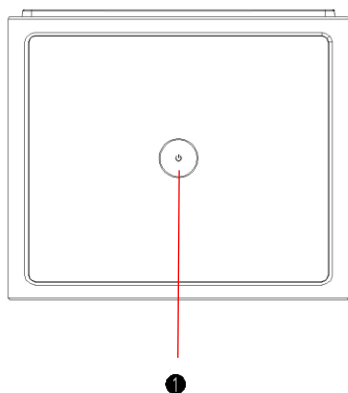

1. Power Switch

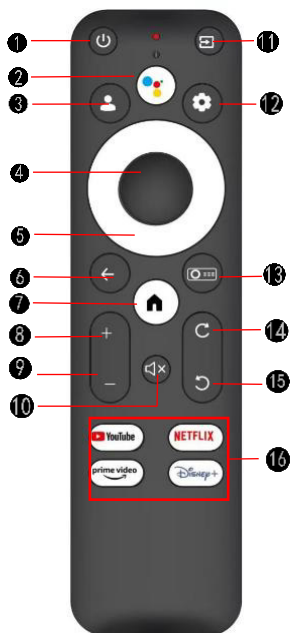

- 1.Power Switch
- 2.Voice remote control
- 3..Menu Button
- 4.Confirm Button
- 5.Direction Button
- 6.Back Button
- 7.Home Button
- 8.Volume+
- 9.Volume-
- 10.Mute
- 11.Signal Source
- 12.Set up
- 13.Projection Settings
- 14.Lens Forward
- 15.Lens Backward
- 16.Enter with one click

Getting Started Projector Placement

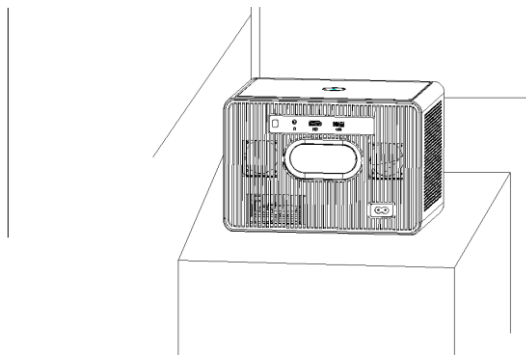

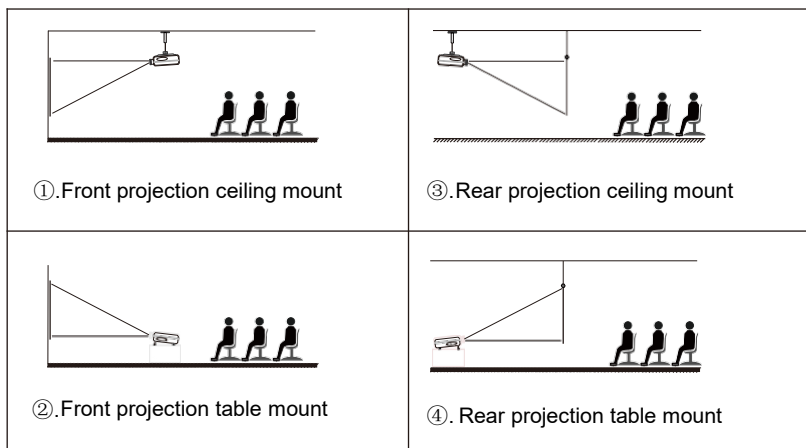

Note:

- (1) During the installation process, please do not operate with electricity to avoid electric shock hazard and projector circuit failure.
- (2) Please keep a gap of at least 30 cm from the wall. Do not cover or block the projector's vents with any objects. Make sure that the projector has enough ventilation to ensure the projector's performance and reliability.
- (3) If you have a projector screen and need to be mounted on a ceiling, the

Ceiling installation

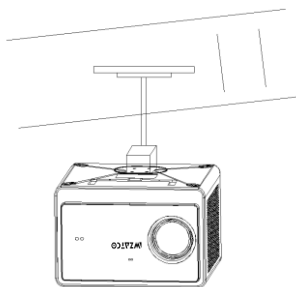

Screw holes

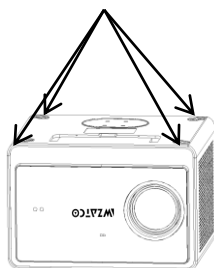

1. Please purchase an universal projector ceiling mount;
2. Remove the four rubber pads on the button of the projector, you will see the screw holes and use the M4*10mm screws for installing the ceiling, and then install it.

Start Using

Power On

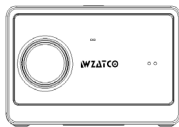
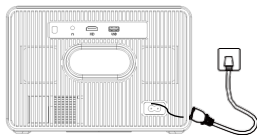

1

2 Take off the lens cover.

3

Projector Distance & Size

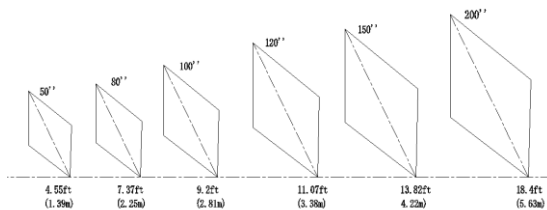

Aspect Ratio (16:9)	
Distance	Screen Size (inch)
4.91ft (1.5m)	53
7.37ft (2.25m)	80
9.2ft (2.81m)	100
11.07ft (3.38m)	120
13.82ft (4.22m)	150
18.4ft (5.63m)	200

Adjusting the projected image (Autofocus)

After adjusting the size and distance of the projector, if it is still unclear, press the remote control F+/F- to adjust until a clear image is obtained



Auto access screen (Autofocus)

Step 1: Use the Projection Settings button on the remote control to select Advanced settings.

Step 2: Select "Auto Screen Input" in the "Advanced Settings" column. Press the confirm button, and after the projector refocuses, the screen size will be adjusted to the screen size

Note: The curtain needs to be selected with a black border, otherwise it will not enter the curtain successfully. When entering the curtain automatically, please make sure that the corners of the curtain are in the projection screen.

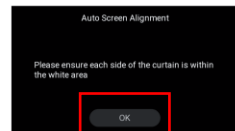
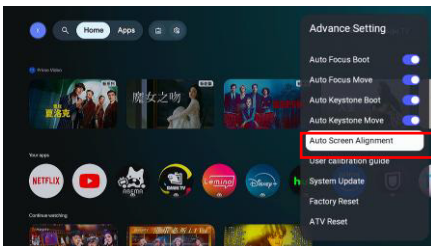
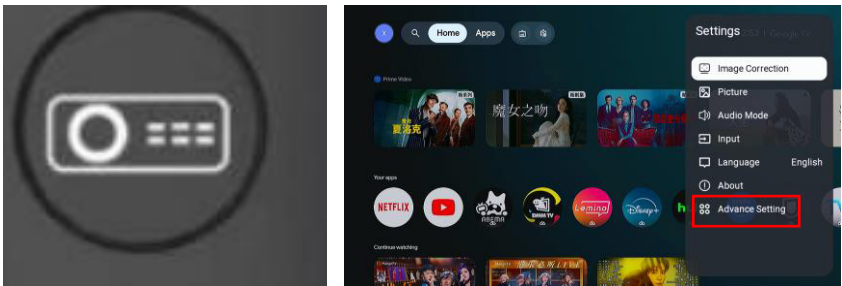

Step 1: Use the Projection Settings button on the remote control to select Advanced Settings.

Step 2: Select "Image Correction" in the "Advanced Settings" column, press the confirmation key to enter manual key correction, press the remote control direction key to zoom the screen size, and press the confirmation key to switch the next corner.

Note: The projection screen can only be reduced or not enlarged. If the screen cannot be covered, please back the projector back

After adjusting the screen, turn off autofocus and auto trapezoid in advanced settings

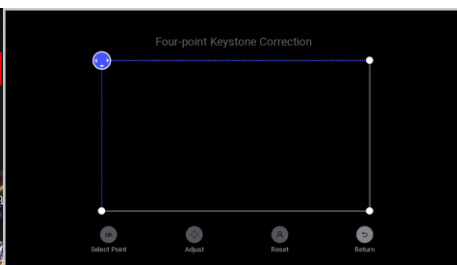
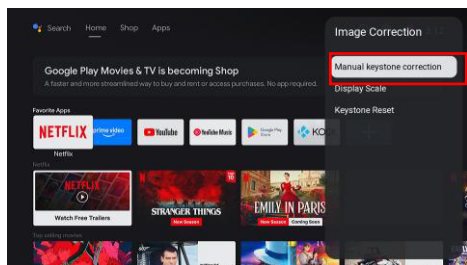
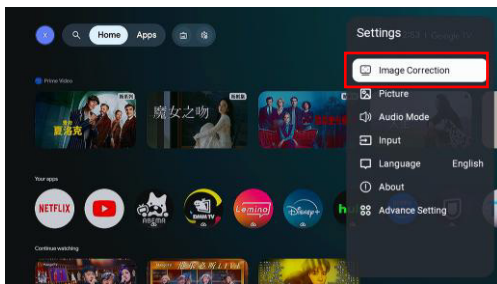

Input Source

A.HDMI mode

Step 1: Connect the projector and equipment with HDMI cable.

Step 2: Press and hold the <Source button> on the projector or on the remote control to enter the input source interface and select HDMI.

Step 3: Press the HOME button to exit and return to the main interface of the projector.

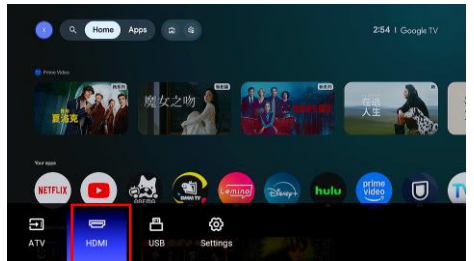
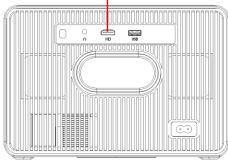

B.USB mode

Step 1: Download the RS File player or other player from the Google Play Store

Step 2: Insert the USB flash drive and open the player app to play

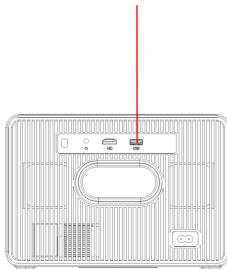

Bluetooth mode

How to connect the projector to external speakers:

Step 1: Use the remote control or the projector button to enter the setting interface of the projector

Step 2: Find the Bluetooth settings on the setting interface, press OK to enter the Bluetooth settings, select Add accessory, a list of Bluetooth devices will be displayed

Step 3: Select the Bluetooth speaker from the device list to connect, then press OK to pair.

Step 4: After successful connection, it will show connected on the Bluetooth device.

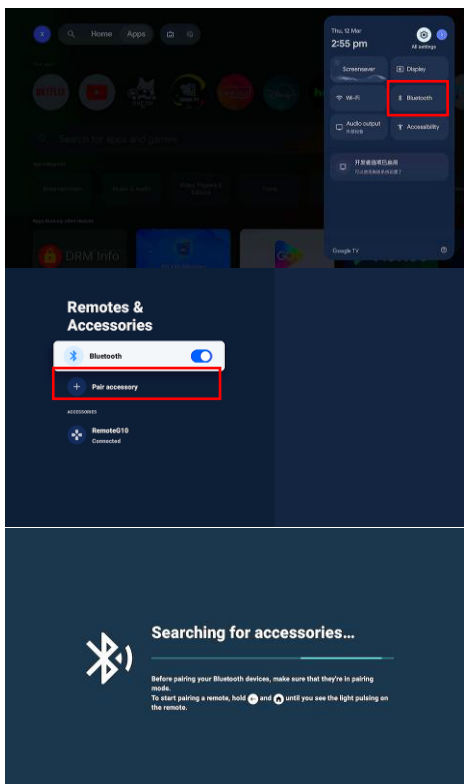

Specifications

Display Technology	LCD	Light source	LED
Aspect Ratio	16:9/4:3/Auto	Focus	Manual
Keystone	$\pm 30^\circ$	Projection mode	Front / Rear / Ceiling
Speaker	10W*2	Power supply	AC100-240V , 50 / 60HZ
Unit Dimension	246*207*169	Unit net weight	3.5kg
Photo FormatSupported	JPG/JPEG/PNG/BMP	Audio formatsupported	MP3 / AAC / FLAC / OGG / WAV/ WMA / MID / DTS / M4A
Video FormatSupported	3GP / AVI / FLV / MP4 / MPG /VOB / TS / M2TS / RMVB / MKV	Ports	HDMI *1 / USB 2.0 *1 / Audio in*1

Trouble Shooting

Q1.Blurry Image

- Make sure the projection distance is farther than the minimum projection distance of 1.53 m.
- Adjust focus ring.

Q2.The projector image shows no signal

- Please make sure all cables are connected to the projector properly and stably.
- Check whether the projector input source mode has been selected as the corresponding format.
- For example:the device and the projector are connected with an HDMI cable, the HDMI input channel must be selected for projection,and no signal will be displayed if other channels are selected.

Q3.Remote Unresponsive

- Make sure remote points at IR receiver directly.
- Do not cover IR receiver.
- *Try a new pair of AAA batteries.

Q4.The projector will stop automatically every after time it is used for a period of time

- Check if the projector's air inlet and outlet are blocked by other objects.
 - Please pay attention to whether the local mains voltage is too low or too high or fluctuates too much.
-

Register Warranty



Scan the QR code
to register your e-warranty now!
Registration is mandatory

DEMO VIDEO



Scan the QR code
to watch the demo video and
explore the features
of your projector

RAISE A TICKET



Scan the QR code to raise a
ticket at
help.wzatco.com
and get prompt assistance
from our support team.

NEED ASSISTANCE?



+91 80-7097-7097
support@wzatco.com
Our support team is available
Monday to Saturday,
10:00 AM – 5:00 PM (IST).